

Display Pad

Part number: 90-60-545 Display Pad White
90-60-546 Display Pad Carbon



User Guide & Installation manual

V1.3

1. introduction	3
2. operation	3
2.1 Key pad description	3
3. Settings of the <i>Display Pad</i>	5
3.1 Set up an address for the <i>Display Pad</i>	5
3.2 Key sound	5
4. Use in a topline Bus.....	6
4.1 Select of a display	6
4.2 Shortcut Pages A, B, C, D	7
4.3 Timer	7
4.3.1 Key TIMER and SYNC.....	7
4.3.2 Key OK (T1 et T2).....	8
5. Installation	9
5.1 <i>Display Pad</i> packing list.....	9
5.2 Wiring the <i>Display Pad</i>	9
5.3 Mounting the <i>Display Pad</i>	10
6. Specifications of the <i>Display Pad</i>	11
7. Firmware evolution for the <i>Display Pad</i>	12

1. INTRODUCTION

The Display Pad is a control for the Topline Bus. It is used to control Multidisplay, Multigraphic displays, to manage the timer and the display standby control.

2. OPERATION

The **Display Pad** is given a node address, like a display. When the **Display Pad** is powered for the first time, the default address is 0 (factory setting). It will be necessary to define a node address for the Pad Pilot to be recognised and to operate on the Topline Bus.

2.1 Key pad description

The **Display Pad** has 10 keys. They are used to control the display, to access the menu, manage the Display and the Timer.

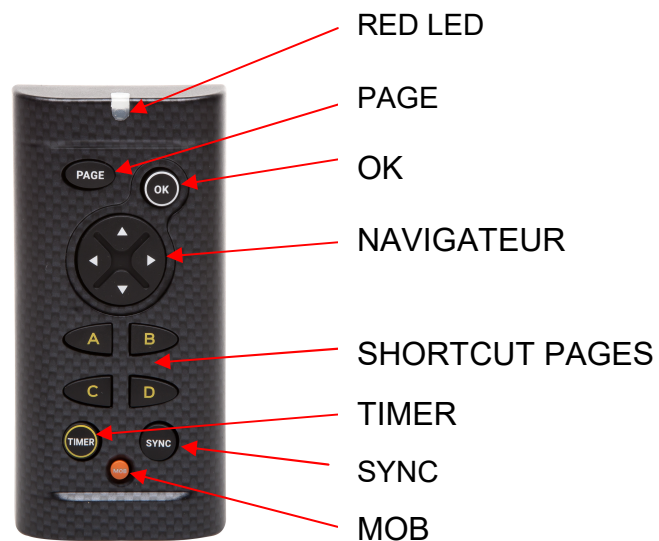

- **RED LED**

Led indicating the current mode for the **Display Pad** (display selection mode, set-up mode)
Flashes at each press.

- **PAGE**



Use this key to navigate in various displays of the Toplevel range. Press and hold to access the display selection mode.

This key is also used to access the displays' menus, to scroll the pages and for the "back/return" function.



Press and hold (at least 3 seconds) to open the Menu page.

- **OK**



This key is used to confirm a selection.



Press and hold (at least 3 seconds) to open the settings page for backlighting.

- **NAVIGATEUR**



Use the left and right arrows to select the display. It is also used to navigate in the menus and pages of the selected display.

- **RACCOURCIS PAGES (A, B, C, D)**



Keys A, B, C, D are used to call up programmed pages or the standby command for Multigraphic and Multidisplay displays.

- **TIMER**



To Launch and stop timer

- **SYNC**



To synchronize the timer

- **MOB** 







Press and hold this key to trigger a Man Over Board function on the Topline bus.

3. SETTINGS OF THE *DISPLAY PAD*



3.1 Set up an address for the *Display Pad*

When the *Display Pad* is powered for the first time, the default address is 0, the LED flashes once per second, waiting for the operational node address. Press  to allocate an address.

If the *Display Pad* already has an address, there are two possibilities:

- You wish to allocate a new address:
Press  +  simultaneously until you hear an audible signal (3 seconds) and the LED flashes once per second. You've accessed the setup mode. To allocate a new address, press .
- You wish to set reset the default address (0):
To do this, press  +  simultaneously during 3 seconds, until you hear an audible signal and the LED flashes once per second. The address 0 is allocated to the *Display Pad* by pressing . This restores the setup as it was when the device was powered for the first time.

3.2 Key sound

Every time you press on a key on *Display Pad*, this generates a sound. This sound can be disabled by entering the setup mode with  +  during 3 seconds until you hear a Beep and then press the right arrow of . Repeat the procedure to activate the key sound.

4. USE IN A TOPLINE BUS









4.1 Select of a display

To select a display with the **Display Pad**, press  until the second beep (5 seconds). You've accessed the selection mode. Then press on the left or right arrow to toggle between displays. You may press several times until you find the desired display.





This operation is required on the first use, as by default no display is selected.



- Selecting TL25:

Press on  until the second beep, then with  and left and right arrows you can select the TL25. Once the TL25 is selected, the upper line flashes. Press  to confirm this display is selected. Then you can modify the upper line using up and down arrows of . To change line, use . Press and long hold  to access the sub-channel. Press  to change the sub-channel. Press and hold long  to exit.

- Selecting Multigraphic:

Press  until you hear a second beep and choose a display using the left and right arrows of : Once Multigraphic has been selected, a remote control (version 2.3) or a yellow box (version 2.4) appears, then press  to confirm. The keypad works the same way as the one on the Multigraphic. Refer to the manual of Multigraphic V2.4 or newer.

- Selecting Multidisplay:

Press  until you hear a second beep and choose a display using the left and right arrows of : Once the Multidisplay has been selected, a yellow box appears and press  to confirm. Refer to the Multidisplay manual.

4.2 Shortcut Pages A, B, C, D

Keys A, B, C, D are used to call up programmed pages or the standby command in the Multigraphic and Multidisplay displays.

Example: I have a Display Pad, a Multidisplay and a Multigraphic in my Topline installation. My two displays have the A key programmed. When I press the A key on my Pad, I bring up the programmed page of each display. For the display standby command, pressing once switches the display to standby and then waking it up.

4.3 Timer

4.3.1 Key TIMER and SYNC

TIMER and SYNC direct access to the timer. For pressing these keys to have an effect it is necessary that:







A page with the TIMER channel has been created on at least one bus display.

That in the reactions to the SYNC shortcut the display of the page in question has been programmed. Settings menu> Shortcut configuration> Sync shortcut - Goto page X.

3 states for the TIMER:

- 1/ Not ready, no number is displayed ----
- 2/ Ready to launch. The time T1 is displayed.
- 3/ In process, the time decrease.

At first display the TIMER channel:

- To synchronize the TIMER, push longtime on , T1 is display.
- To change T1 push on  one or many time.
- To launch TIMER push on .
- If you have delay, synchronize at the closest minute. Push .
Ex : If the TIMER display 1mn32 it will synchronize at 2mn and if the display 1mn24, it will synchronize at 1mn.
- To stop the TIMER push  and push again  for restart the TIMER.
- To prepare the TIMER push long time .

Once on the TIMER page you can also press  to arm your TIMER via the menu. (§4.3.2)

4.3.2 Key OK (T1 et T2)

When you select a Multidisplay or a Multigraphic with the Display Pad and you display a page where the TIMER channel appears, pressing  causes the appearance of popup windows:

- First popup: "Arm TIMER T1". The TIMER channel displays the duration "T1" configured in the "TIMER" sensor instead of the 4 lines indicating that the data is empty.
- Second popup: "Start TIMER". The TIMER channel will count down the seconds from T1.
- Third popup: "Synchronize T2". This allows for example to reset the stopwatch to a phase of the procedure such as the preparatory signal at 4 minutes.
- Fourth popup: "Stop TIMER". This returns to the empty channel with 4 lines.

5. INSTALLATION



WARNING

Turn the power supply **OFF** before doing any work on the **TOPLINE Bus**.

5.1 *Display Pad* packing list



- A **Display Pad** with a six meters cable.
- A protection cover.
- A Fixamo M14.
- A plastic M14 nut.

5.2 *Wiring the Display Pad*

- Connect the bus cable to a Topline junction box as follow:

White wire on "**+12 V white**" or "**+/white**"

Shield on "**GND**" or "**-/nu**"

Black on "**Data black**" or "**D/black**"

5.3 Mounting the *Display Pad*

There are several ways to mount the *Display Pad*:



An 18 mm diameter hole is required to allow the cable running as well as the mounting kit.



If the supporting surface is between 1 and 3mm: Screw the plastic nut by hand.



If the supporting surface is between 3.1 and 40 mm: Screw by hand the Fixamo to the unit and then the plastic nut.

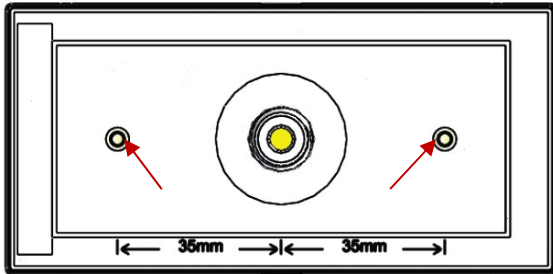

Alternatively, you can use the two inserts at the back of the Pad, and screw two M3 screws.

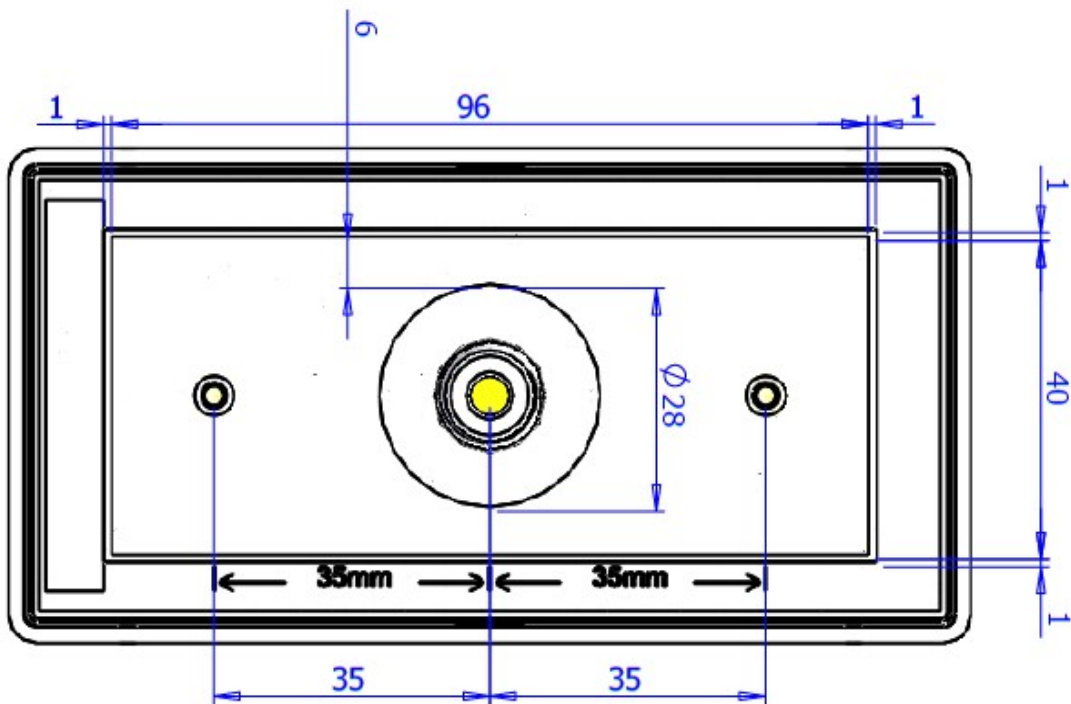

DRILLING TEMPLATE

6. SPECIFICATIONS OF THE *DISPLAY PAD*

Parameter	Value
Dimensions	With protection cover (mm): 122 x 62 x 27 (Length x Width x Depth) Without protection cover (mm): 115 x 58 x 23 (Length x Width x Depth)
Mounting kit	- Hand-screw nut M14 (part Nr: 30-95-032) - Fixamo M14 (part Nr: 30-95-031)
Weight	350g with 6m of cable (32g/m) and protection cover
Power supply	8V – 32V DC
Operational consumption @ 12 V	< 30mA
Topline bus power cable	Ø5.5mm, 2 wires + ground, length 6m
Operational temperature	-10°C / 50°C
Storage temperature	-20°C / 60°C
Protection rate	IP7 waterproof to water projections

7. FIRMWARE EVOLUTION FOR THE *DISPLAY PAD*

REV	Date	Information
V1.0	21/06/2018	- Original version
V1.1	08/11/2018	- Bug correction for long auto shortcut - Possibility to acknowledge the TOPLINE Bus audible alarms - Compatibility with HR and Regatta processors
V1.2	11/03/2020	- Removal of standby of the pad
V1.3	09/07/2020	- Fixed address acquisition bug