

APPARENT WIND MONITOR

Part number: 90-60-398



USER MANUAL & INSTALLATION SHEET

V1.1

1	Introduction.....	3
2	Operation.....	3
2.1	Galvanic isolation.....	3
2.2	Wind sensor selector.....	3
2.3	Wind data denoising.....	4
2.4	LEDs Status.....	4
3	Setting up the <i>Apparent Wind Monitor</i>	5
3.1	Setting up the mast height.....	5
3.1.1	Setup with a Multigraphic.....	5
3.1.2	Setup with a Multidisplay.....	6
3.2	Mast angle setup.....	6
3.2.1	Mast angle sensor setup with a <i>MULTIGRAPHIC</i>	6
3.2.2	Setting up the Mast Angle with a <i>Multidisplay</i>	7
4	Installation.....	8
4.1	Wiring from the Apparent Wind Monitor.....	9
4.2	NMEA output.....	10
5	Specifications of the APPARENT WIND MONITOR.....	11
5.1	Dimensions (mm) of the housing of <i>Apparent Wind Monitor</i>	11
5.2	<i>Apparent Wind Monitor</i> specifications.....	12
6	Apparent Wind Monitor firmware history.....	13

1 INTRODUCTION

The **Apparent Wind Monitor** features **4** functions.

The **Apparent Wind Monitor** electrically isolates the wind sensor line (cable and mast head unit), which is the part of the installation the most exposed to storm surges and short-circuits due to wires' chafing.

The **Apparent Wind monitor** corrects the wind data from the boat's accelerations; thus enhancing the autopilot performance, as data filtering is reduced, as well as power consumption.

The **Apparent Wind monitor** is a switch for three aerial sensor lines.

The **Apparent Wind monitor** is an interface for the mast angle sensor.

2 OPERATION

Data coming from the wind sensor are transmitted to the Topline Bus through the **Apparent Wind Monitor** through channels:

- Apparent Wind Angle "AWA"
- Apparent Wind Speed "AWS"
- Air temperature

2.1 Galvanic isolation

The primary function of the **Apparent Wind Monitor** is to electrically isolate the mast cable and the mast head unit from the rest of the Topline Bus installation.

In case of a short circuit in the cable or the wind sensor, the installation is not affected and the system continues to operate (the TOPLINE Bus is protected).

If the mast head units cease to communicate, it is the interface which broadcasts the "AWA" and "AWS" channels as well as the error messages.

If a wind sensor is not in use, its three wires are connected to the common ground of the three aerial sensors, which is not the common ground of the TOPLINE Bus (for isolation purposes). This connection to ground is done automatically by the **Apparent Wind Monitor**.

Thus, the TOPLINE Bus is robust to resist to a wind sensor failure.

2.2 Wind sensor selector

The interface features three inputs.

The main wind sensor is connected to input 1.

Input 3 is dedicated to the wind sensor which is directed to the aft of the boat.

The selector features 4 positions:

- 1, 2 or 3 are used to select the relevant wind sensor. It also allows to set up the **Apparent Wind Monitor** and to calibrate the selected wind sensor.

- Automatic: Depending on the sensors' condition, the **Apparent Wind monitor** selects the sensor to be used, giving priority to the main sensor, Nr 1. In case of a short circuit on the Input 1, the **Apparent Wind Sensor** switches automatically to Input 2 if there is a sensor connected to that port.

Mounting example: Carbowind is on the Input 1 as main wind sensor and AG HR on Input 2 as backup sensor.

2.3 Wind data denoising

This function is available only with HR type sensors (Carbowind and AG HR).

Denoising is processed with the help of a 6 axes IMU (*Inertial Measurement Unit*) 6 axes integrated in the **Apparent Wind Monitor**, providing instant boat's attitude/behaviour. Therefore, the **Apparent Wind Monitor** must be installed close to the mast foot (refer to Installation chapter)

The boat's attitude/behaviour data combined with the mast height, already entered via a Multigraphic V2.4 (or newer), are used to correct the raw wind data coming from the mast head unit. The result gives "denoised" apparent wind angle and apparent wind speed.

2.4 LEDs Status

Three LEDs wind sensor and one LED mast angle are featured on the front.

- Status of the wind sensor LED AG1 – AG2 – AG3:

Green: Wind sensor manually or automatically selected and correct operation of that sensor.

Red: relevant sensor is faulty. Selected sensor is faulty or not present.

Off: Not selected

- LED for mast rotation sensor:
- Fixed green when the function is enabled and the sensor connected
- Flashing red when the function is activated and the sensor not connected or out of order
- Off when the function is disabled

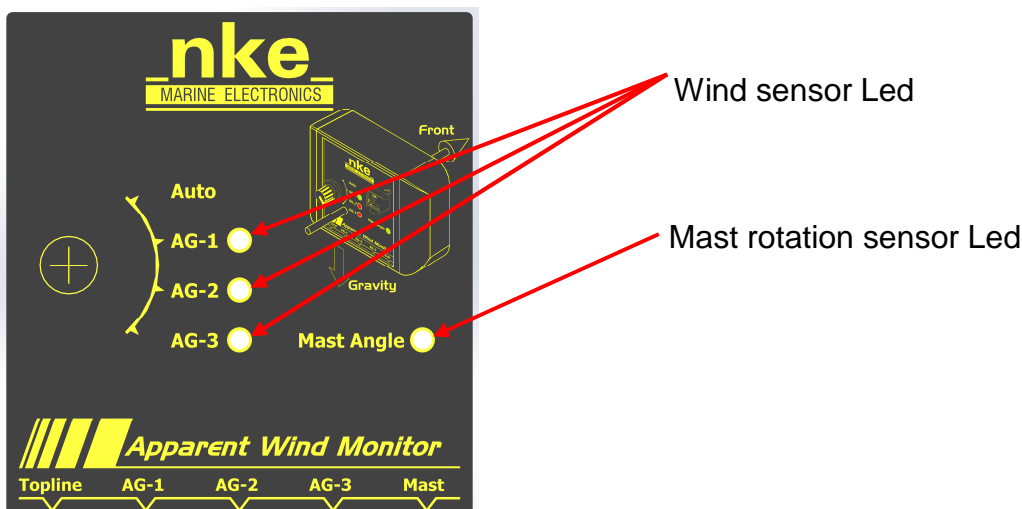

3 SETTING UP THE APPARENT WIND MONITOR.

The Apparent Wind Monitor setup is done with a Multigraphic V2.4 or newer.



WARNING

To set up one of the wind sensors (Offset, True Wind table, mast height...), place the selector on the relevant sensor. The Apparent Wind Monitor integrates the wind tables for one sensor only. These tables are the same for all three wind sensors. The wind tables are integrated in the **Apparent Wind Monitor**, which broadcasts them at the installation start.

3.1 Setting up the mast height



The mast height is required for data denoising.

The value is the measurement between the mast head unit and the **Apparent Wind Monitor** housing. It is expressed in metres and must be entered for each wind sensors' setup.

Entering the value "0" for the mast height results in disabling the denoising function.

The mast height setting is done in the AWS menu.

3.1.1 Setup with a Multigraphic

Press and hold  to access the menu from which you can select  to display the "Sensors" page.

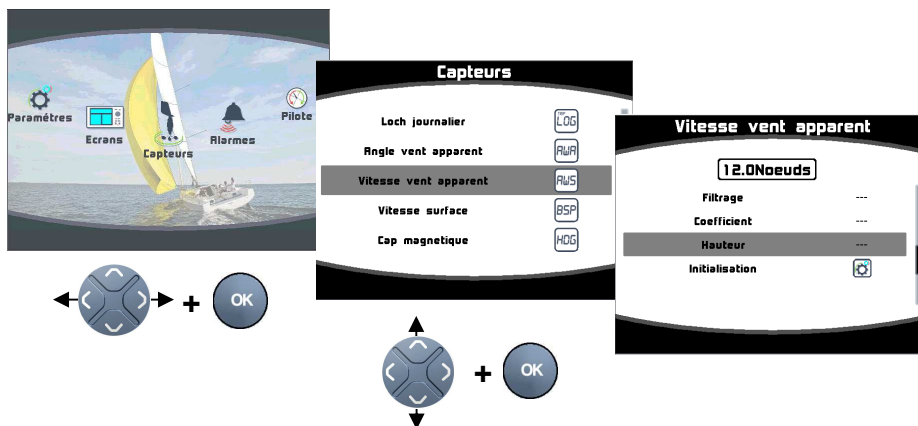

3.1.2 Setup with a Multidisplay

The mast height setup is done with a Multidisplay in the same way as with a Multigraphic.



In the sensor menu, select Apparent Wind Speed, and then the height value. Enter the value and confirm with OK.

3.2 Mast angle setup

Done by your installer: Enabling the mast angle function (if a sensor is connected):

The mast angle function is disabled by default (factory settings) on the Apparent Wind Monitor. With the help of the Toplink software, enable this function and set the **MAST_SENSOR** value to 1.

3.2.1 Mast angle sensor setup with a *MULTIGRAPHIC*

Press and hold  to access the menu from which you can select  to display the "Sensors" page. Select the mast angle function created by the **Apparent Wind Monitor**.

- Configuration of the mast angle offset

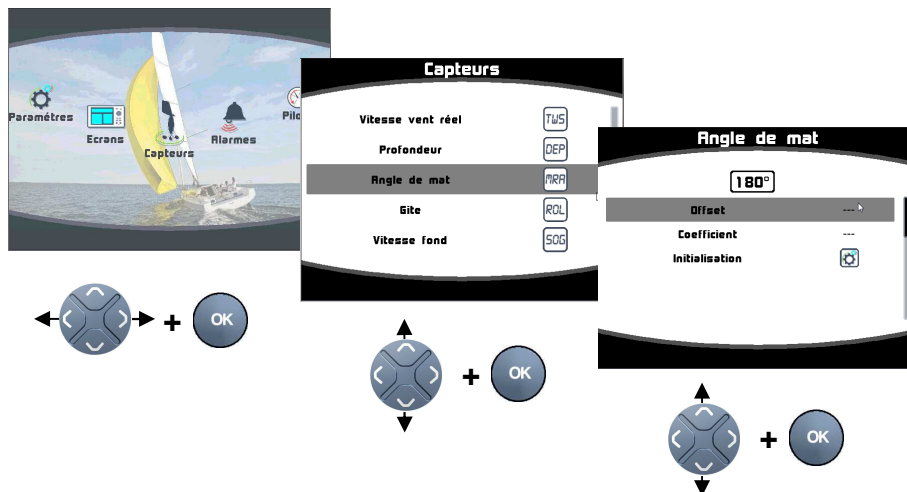

- **Setting up the mast angle coefficient**

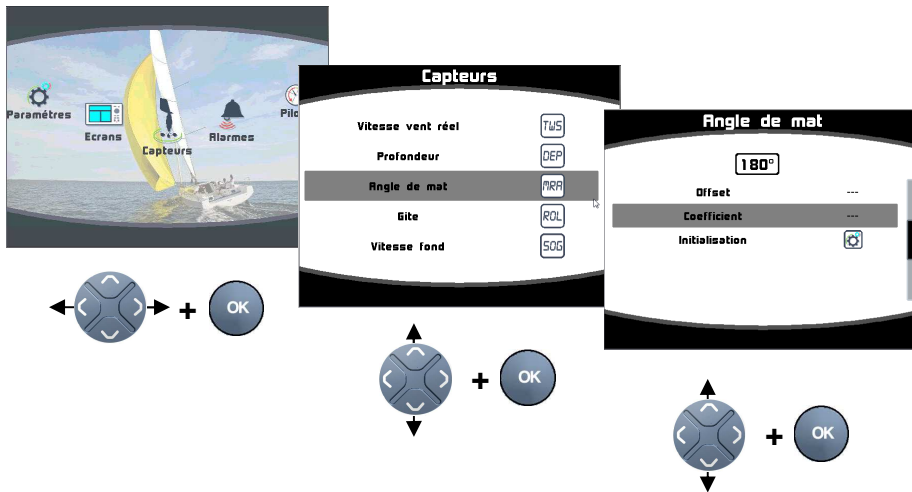

Reset = full factory reset of the **Apparent Wind Monitor's** mast angle part.

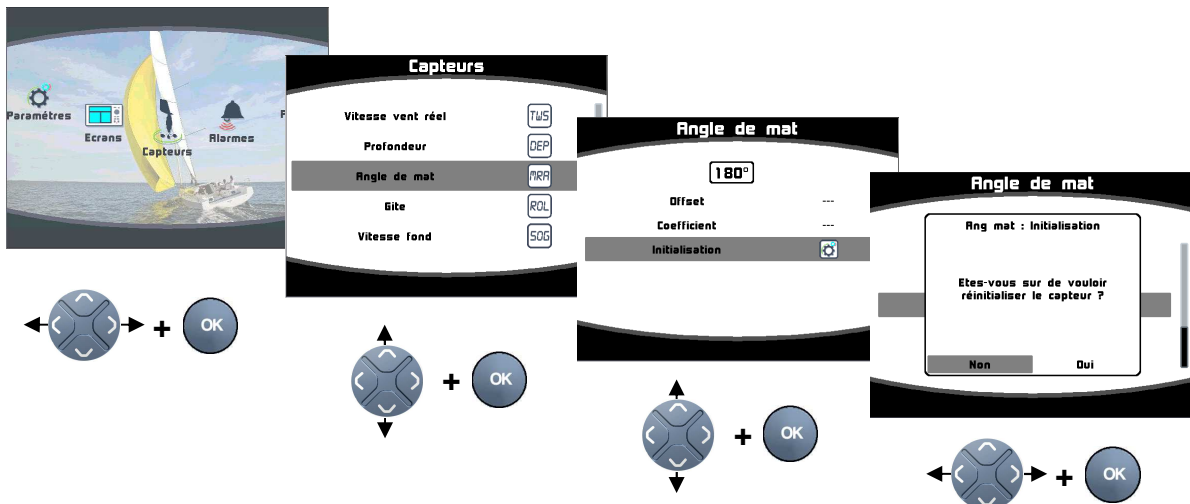

3.2.2 Setting up the Mast Angle with a Multidisplay

The mast angle setup is done with a Multidisplay in the same way as with a Multigraphic.

In the Sensor menu, select Mast Angle, set an offset value and confirm with OK. You can edit coefficient in the same way.

Reset = full factory reset of the **Apparent Wind Monitor's** mast angle part.

4 INSTALLATION



warning

Turn the power supply off before doing any work on the TOPLINE Bus.

The Apparent Wind Monitor must be mounted on a vertical bulkhead with the face turned to the boat's aft (standard mounting) or to the bow (reverse mounting). It must be perfectly horizontal for the best denoising result. See below for a reverse mounting.

Standard mounting:

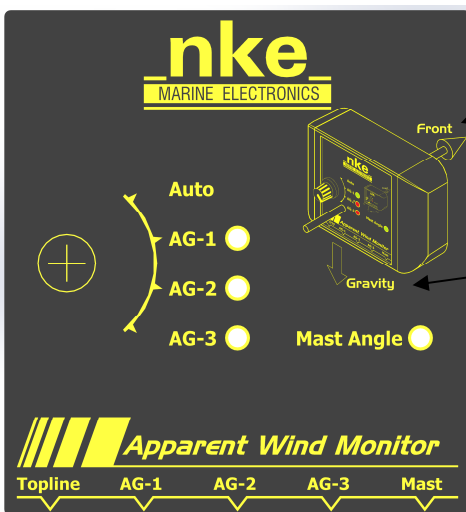

Front: To the boats bow.

Gravity: Bulkhead mount, cables
horizontal
(parallel to the boat's
deadweight trim)

Reversed mounting:

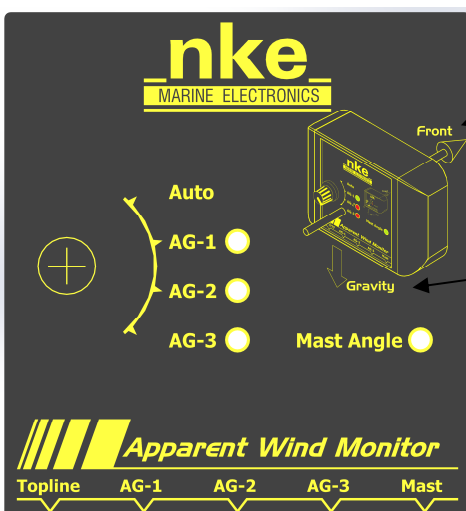

Front: to the aft of the boat.

Gravity: Bulkhead mount, cables
horizontal
(parallel to the boat's

For a reversed mounting, you must use the Toplink software and set the **IMU_INSTALL_TYPE** value to 1.

4.1 Wiring from the Apparent Wind Monitor

To open the housing, you access the screws located below the two side flaps. Use a cross-head screwdriver to open the housing.

Run the sensor's cables through the dedicated glands. Use silicone grease to facilitate the cables passage. Strip the cable over 10 cm and put a heat-shrink sleeve on the braid to prevent short-circuits. Tin the cables over 5mm and place them on the relevant terminals. Add a plastic cable tie next to the gland, to protect the connection in case of accidental traction on the cables.

Connection:

- Bus cable welded on the board
- The 3 wind sensors and the mast angle sensor are connected to the terminal on dedicated positions. White wire: 12V; braid: GND; black wire: DATA.

The main wind sensor must be connected to AG1 input.

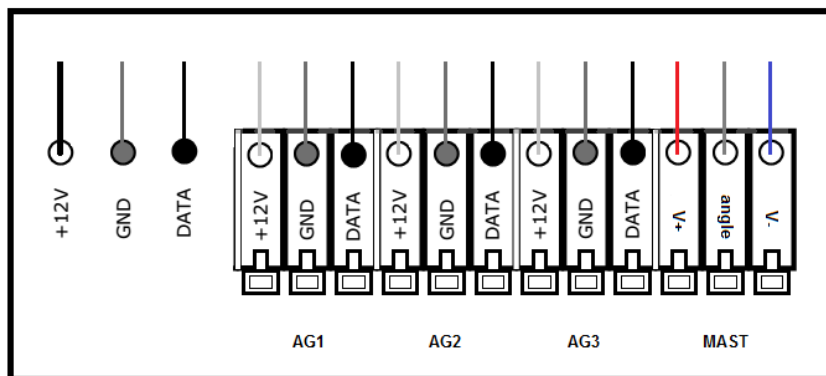

External connection:

Connect the bus cable to a Topline junction box as follow:

- White = +12 V
- Braid = GND
- Black = Data
- Red = NMEA0183 output
- Yellow = NC
- Green = NC

Mast Angle wiring

Mast Angle connector	Description	Rudder and Mast Angle sensors 90-60-010 and 90-60-388
V+	V+ (3.3V)	Red
V-	V- (0V)	Blue
Angle	Data	White

If the rotating direction is displayed reversed, you must swap the red (V+) and blue (V-) cables.



WARNING

If the installation includes a mast foot junction box for the mast head unit connection, only the wind sensor's mast cable will be connected to that box. The mast head unit cable is no longer connected to the Topline Bus. It goes through the **Apparent Wind Monitor**, which isolates it from the bus.

4.2 NMEA output

The NMEA sentence \$PNKEV is sent when the system is powered. With it, you can check the firmware version, as well as the date and time of compilation.

```
$PNKEV,Wind Monitor nke,V1.0,Jun 29 2018,09:50:41*7F
```

5 SPECIFICATIONS OF THE APPARENT WIND MONITOR

5.1 Dimensions (mm) of the housing of *Apparent Wind Monitor*

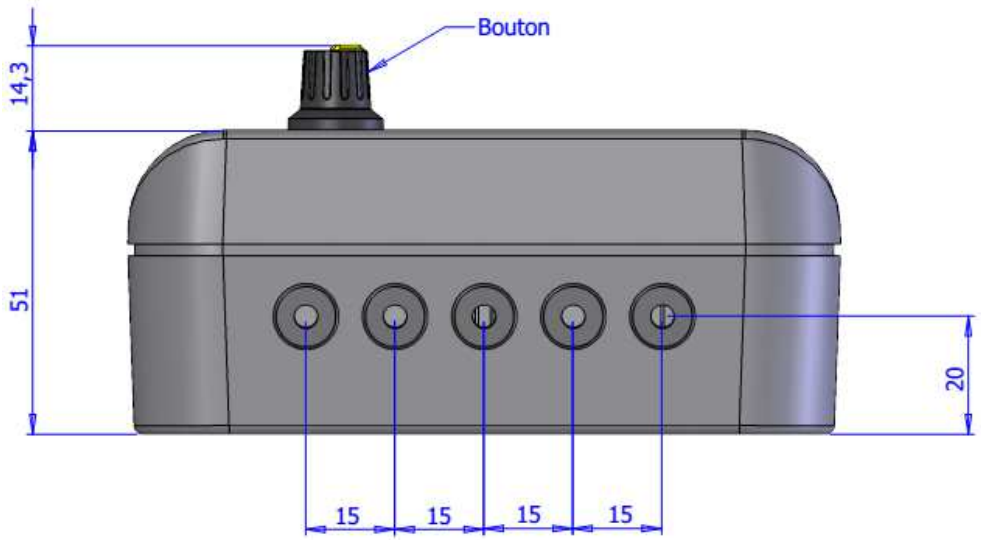

5.2 Apparent Wind Monitor specifications

Parameter	Value
Power supply	8V – 32V DC
NMEA output	NMEA0183 38400 bauds
Weight	360 gr with cable
Operational consumption @ 12 V	100mA
Topline bus power cable	Ø5,5mm, 4 wires + ground, length 3m
Wind sensors connections	3 wind units inputs, 3 wires
Mast Angle connector	1 input, 3 wires
Operational temperature	-10°C / 50°C
Storage temperature	-20°C / 60°C
Protection rate	IP54, Waterproof to water projections

6 APPARENT WIND MONITOR FIRMWARE HISTORY

REV	Date	Information
V1.0	29/06/2018	<ul style="list-style-type: none">• Original version
V1.1	24/01/2019	<ul style="list-style-type: none">• True Wind Tables added